

OpenAir™

GMA Series, Spring Return, 62 lb-in, Rotary, Electronic Damper Actuators



Description

The OpenAir direct-coupled spring return electronic actuator is designed for modulating, two-position, and floating control of building HVAC dampers.

Features

- Brushless DC motor technology with stall protection
- Bi-directional fail-safe spring return
- Models available with dual, independently adjustable auxiliary switches
- Unique self-centering shaft coupling
- Manual override
- Available in 62 lb-in torque
- 5° preload as shipped from factory
- Mechanical range adjustment capabilities
- UL and cUL listed, CE certified
- 24 Vac/dc compatible

Application

Used in constant or variable air volume installations for the control of return air, mixed air, exhaust, and face and bypass dampers requiring up to 62 lb-in (7 Nm) torque.



Designed for applications that require the damper to return to a fail-safe position when there is a power failure.

Product Numbers

Table 1.

| Product Number | Operating Voltage | | Control | | | | Cables | | Built-In Control Options | | | | | |
|----------------|-------------------|-------------|--------------|------------------------|------------------------|----------|------------|----------|--------------------------|-------------------|-------------------------|---------------------------------------|--|---------------------------|
| | 24 Vac ±20% | 24 Vdc ±15% | 120 Vac ±10% | Modulating 0 to 10 Vdc | Modulating 2 to 10 Vdc | Floating | 2-position | Standard | Plenum | Position Feedback | Dual Auxiliary Switches | Offset 0 to 5 Vdc Span 2 to 30 Vdc | Input Signal Inversion (Direct or Inverse Acting) | Feedback Signal Inversion |
| GMA121.1U | • | | | | | | • | • | | | | | | |
| GMA121.1P | • | | | | | | • | | • | | | | | |
| GMA121.1P/B | • | | | | | | • | | • | | | | | |
| GMA126.1U | • | | | | | | • | • | | • | | | | |
| GMA126.1P | • | | | | | | • | | • | | | | | |
| GMA221.1U | | • | | | | | • | • | | | | | | |
| GMA226.1U | | • | | | | | • | • | | | • | | | |
| GMA131.1U | • | | | | | • | | • | | | | | | |
| GMA131.1P | • | | | | | • | | | • | | | | | |
| GMA132.1U | • | | | | | • | | • | | • | | | | |
| GMA136.1U | • | | | | | • | | • | | | • | | | |
| GMA151.1U | • | | | • | | | | • | | • | | • | • | • |
| GMA151.1P | • | | | • | | | | • | | • | | • | • | • |
| GMA156.1U | • | | | • | | | | • | | • | | • | • | • |
| GMA156.1P | • | | | • | | | | • | | • | | • | • | • |
| GMA161.1U | • | | • | | | | | • | | • | | | | |
| GMA161.1P | • | | • | | | | | • | | • | | | | |
| GMA163.1U | • | | • | | | | | • | | • | | • | | |
| GMA163.1P | • | | • | | | | | • | | • | | • | | |
| GMA164.1U | • | | • | | | | | • | | • | • | • | | |
| GMA166.1U | • | | • | | | | | • | | • | • | | | |
| GMA166.1P | • | | • | | | | | • | | • | • | | | |

Warning/Caution Notations

| | | |
|-----------------|---|--|
| WARNING: |  | Personal injury/loss of life may occur if you do not perform a procedure as specified. |
| CAUTION: |  | Equipment damage may occur if you do not perform a procedure as specified. |

| | | |
|-----------------------------|--|---|
| Specifications | Operating voltage | 24 Vac \pm 20%; 24 Vdc \pm 15% |
| | Frequency | 50/60 Hz |
| | Power Supply | |
| 24 Vac/24 Vdc | Power consumption | |
| | running (GMA 12x, 13x, 15x, 16x) | 5 VA/3.5W |
| | holding (GMA 12x, 13x, 15x, 16x) | 4 VA/3W |
| | Equipment rating | Class 2, in accordance with UL/CSA Class III per EN 60730 |
| Power Supply | Operating voltage | 120 Vac \pm 10% |
| 120 Vac | Frequency | 50/60 Hz |
| | Power consumption | |
| | running and holding (GMA 22x) | 7 VA/5W |
| Control Signal | Input signal (wires 8–2) | |
| | voltage input signal GMA16x | 0 to 10 Vdc (max. 35 Vdc) |
| | voltage input signal GMA15x | 2 to 10 Vdc (max. 35 Vdc) |
| | input resistance | >100K ohms |
| Feedback Signal | Position output signal (wires 9–2) | |
| | voltage output signal GMA16x | 0 to 10 Vdc |
| | voltage output signal GMA15x | 2 to 10 Vdc |
| | maximum output current | +1 mA, -0.5 mA |
| Function | Running/spring return torque | 62 lb-in (7 Nm) |
| | Maximum torque | 186 lb-in (21 Nm) |
| | Runtime for 90° | |
| | operating with motor | 90 seconds |
| | closing (on power loss) with spring return | 15 seconds typical (60 seconds max. at -25°F [-32°C]) |
| Mounting | Nominal angle of rotation | 90° |
| | Maximum angular rotation | 95° |
| | Shaft size | 1/4 to 3/4-inch (6.4 to 20.5 mm) dia. 1/4 to 1/2-inch (6.4 to 13 mm) square |
| | Minimum shaft length | 3/4-inch (20 mm) |
| Housing | Enclosure | NEMA 1 IP54 according to EN 60 529 (limited positions; see <i>OpenAir™ GMA Series Installation Instructions</i> (129-307)) |
| | Material | Die cast aluminum alloy |
| | Gear lubrication | Silicone free |
| Ambient Conditions | Ambient temperature | |
| | operation | -25°F to 130°F (-32°C to 55°C) |
| | storage and transport | -40°F to 158°F (-40°C to 70°C) |
| | Ambient humidity (non-condensing) | 95% rh |
| Agency Certification | | UL listed to UL60730 (to replace UL873) cUL certified to Canadian Standard C22.2 No. 24-93 Australian Electromagnetic Compatibility (EMC) per AS/NZS 4251.1/2:1999 (C-tick) |

| | | |
|--|-----------------------------------|--|
| Agency Certification, continued | Low voltage directive (LVD) | 2006/95/EC EN 60 730-2-14 (Type 1) |
| | CE Conformity | Electromagnetic compatibility (EMC) Immunity for all models, except GMA132.xx Immunity for GMA132.xx Emissions for all models |
| Auxiliary Features | Control signal adjustment | |
| | Offset (start point) | Between 0 to 5 Vdc |
| | Span | Between 2 to 30 Vdc |
| | Dual auxiliary switches | |
| | AC rating (standard cable) | 24 to 250 Vac AC 6A resistive AC 2A general purpose |
| | AC rating (Plenum cable) | 24 Vac AC 4A resistive AC 2A general purpose |
| | DC rating (Standard/Plenum cable) | 12 to 30 Vdc DC 2A |
| | Switch Range | |
| | Switch A | 0° to 90° with 5° intervals |
| | Recommended range usage | 0° to 45° |
| | Factory setting | 5° |
| | Switch B | 0° to 90° with 5° intervals |
| Recommended range usage | 45° to 90° | |
| Factory setting | 85° | |
| Switching hysteresis | 2° | |



WARNING:

Apply only AC-line voltage from the same phase or only UL-Class 2 voltage (SELV for CE conformance) to the switching outputs of both auxiliary switches A and B. Mixed operation is not permissible.

NOTE: With plenum cables, only UL-Class 2 voltage (SELV for CE) is permitted.

Specifications, continued

Feedback potentiometer (GMA 132.1U)

| | |
|----------------------|---|
| Sliding contact (P2) | 0 to 1000 ohm <10 mA |
| Load | <1W |
| Voltage | UL-Class 2 (SELV/PELV for CE) <24 Vac/dc |

Miscellaneous

| | |
|-----------------------|--|
| Pre-cabled connection | 18 AWG (0.75 mm ²) |
| Cable length | 3 feet (0.9 m) length |
| Noise level | 40 dBA |
| Life cycle | Designed for over 60,000 full stroke cycles and a minimum of 1.5 million repositions at rated torque and temperature |
| Dimensions | 8-3/8-in. H × 3-1/4-in. W × 2-2/3-in. D (212 mm H × 83 mm W × 68 mm D) |
| Weight | 2.9 lbs (1.3 kg) |
| Country of Origin | USA |

Actuator Components

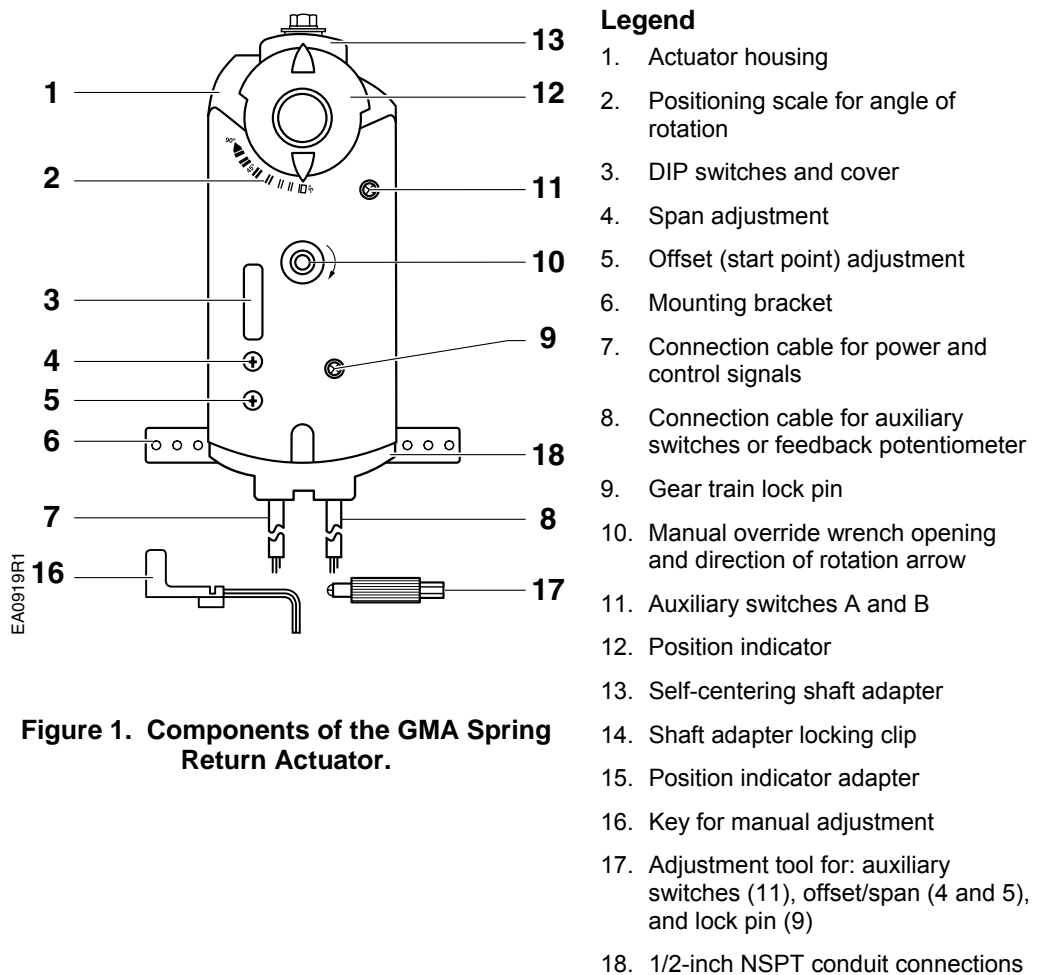
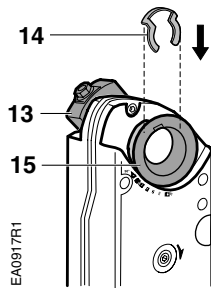

Figure 1. Components of the GMA Spring Return Actuator.

- Legend**
1. Actuator housing
 2. Positioning scale for angle of rotation
 3. DIP switches and cover
 4. Span adjustment
 5. Offset (start point) adjustment
 6. Mounting bracket
 7. Connection cable for power and control signals
 8. Connection cable for auxiliary switches or feedback potentiometer
 9. Gear train lock pin
 10. Manual override wrench opening and direction of rotation arrow
 11. Auxiliary switches A and B
 12. Position indicator
 13. Self-centering shaft adapter
 14. Shaft adapter locking clip
 15. Position indicator adapter
 16. Key for manual adjustment
 17. Adjustment tool for: auxiliary switches (11), offset/span (4 and 5), and lock pin (9)
 18. 1/2-inch NSPT conduit connections

Accessories

NOTE: The auxiliary switches, control signal adjustment, and feedback potentiometer cannot be added in the field. Order the product number that includes the option(s).

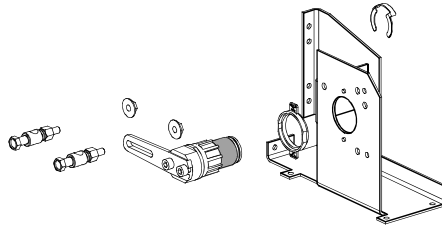

Figure 2. Floor/Frame Mount Kit.

ASK71.11: For in-the-air stream applications; anywhere a foot-mounted actuator can be mounted. Can also be directly mounted to a damper frame with louvers and vents and in applications where use of the floor mount is not possible.

Kit contains:

Crank arm to change the angular rotation into a linear stroke.

Support bearing ring to minimize side loading on the actuator's output bearing.

Mounting bracket, and required mounting fasteners.

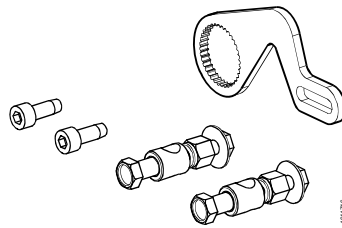

Figure 3. Rotary to Linear Crank Arm Kit.

ASK71.13: Allows a direct-coupled actuator to provide an auxiliary linear drive. Can be used to simultaneously drive a set of opposing or adjacent dampers with a single actuator. Kit contains:

Crank arm to attach to the splined hub of the shaft adapter.

Mounting fasteners.

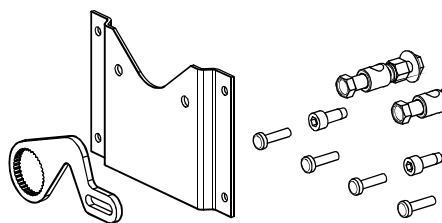

Figure 4. Rotary to Linear Crank Arm Kit with Mounting Bracket.

ASK71.14: Allows economical mounting of an OpenAir actuator to a variety of surfaces. Should be used in applications where the actuator can be rigid-surface mounted and a linear stroke output is required.

Kit contains:

Crank arm to attach to the splined hub of the shaft adapter.

Mounting bracket, and other required mounting fasteners.

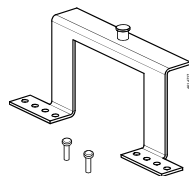

Figure 5. Tandem Mount Bracket.

ASK73.3: Bracket provides an extended anti-rotation pin allowing two actuators to directly drive a single damper shaft (tandem operation).

NOTE: GMA16x and GMA15x must not be tandem mounted.

**Accessories,
 continued**

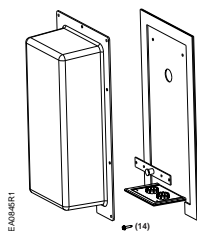

Figure 6. Weather Shield.

ASK75.3U: GMA actuators are UL listed to meet NEMA 3R requirements (a degree of protection against rain, sleet, and damage from external ice formation) when installed with ASK75.3U Weather Shield and outdoor-rated conduit fittings in the vertical position. See Figure 20 for dimensions.

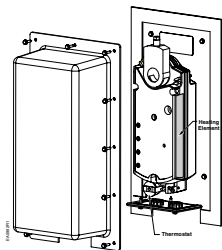

Figure 7. Heater/Weather Shield Assembly.

985-108: Provides protection for 24 Vac/dc OpenAir GMA1xx actuators down to temperatures of -58°F (-50°C).

Assembly includes:

- Weather Shield
- Heater Kit

Service Parts

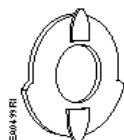

985-094P10
 Position indicators (10/pkg.)

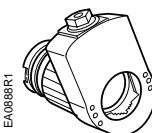

985-093
 Standard shaft adapter.

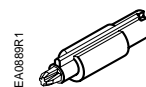

985-098
 Adjustment Tool.

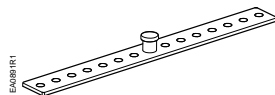

985-092
 Anti-rotation (mounting) bracket.



985-124
 499-ohm resistor assembly kit for 4 to 20 mA applications.

Figure 8. GMA Series Service Parts.

Operation

GMA16x, GMA15x

Apply a continuous 0 to 10 Vdc, or 2 to 10 Vdc control signal between wire 8 (Y) and wire 2 (G0) to operate the damper actuator. The angle of rotation is proportional to the control signal.

A 0 to 10 Vdc or 2 to 10 Vdc position feedback output signal is available between wire 9 (U) and wire 2 (G0) to monitor the position of the damper motor.

In the event of a power failure or when the operating voltage is shut off, the actuator returns to the "0" position.

GMA12x and GMA 22x

When power is applied, the actuator coupling moves toward the open position "90°". In the event of a power failure or when the operating voltage is shut off, the actuator returns to the "0" position.

**Operation,
 continued**

GMA13x

A floating control signal controls the damper actuator. The actuator's angle of rotation is proportional to the length of time the signal is applied. A 24 Vac/dc control signal to wire 6 (Y1) causes the actuator coupling to rotate clockwise. A 24 Vac/dc control signal to wire 7 (Y2) causes the actuator coupling to rotate counterclockwise.

With no control voltage, the damper actuator holds its position. In the event of a power failure, the actuator spring returns to the "0" position.

Overload Protection

In the event of a blockage in the damper, the actuator is overload protected over the full range to prevent damage to the actuator.

Life Expectancy

An improperly tuned loop will cause excessive repositioning that will shorten the life of the actuator.

Sizing

The type of actuator required depends on several factors:

1. Obtain damper torque ratings (lb-in/ft² or Nm/m²) from the damper manufacturer.
2. Determine the area of the damper.
3. Calculate the total torque required to move the damper:

$$\text{Total Torque} = \frac{\text{Torque Rating} \times \text{Damper Area}}{\text{SF}^1}$$

4. Select a spring return actuator using Table 2.

¹Safety Factor: When calculating the total torque required, a safety factor should be included for unaccountable variables such as slight misalignments, aging of the damper, etc. A suggested safety factor is 0.80.

NOTE: Mechanically coupled actuators must be of the exact same type except for the dual auxiliary switches and feedback potentiometer options. Use the correct mounting bracket. See Table 2.

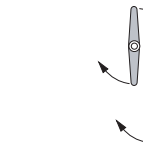
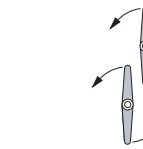





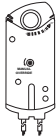









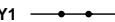









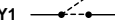



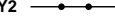











Table 2.

| DC Power (24 Vdc) | | AC Power (24 Vac, 120 Vac) | |
|--|--|---|--|
| Total Torque | Actuator | Total Torque | Actuator |
| <62 lb-in (7 Nm) | GMA1xx | <62 lb-in (7 Nm) | GMA |
| >62 lb-in <160 lb-in (>7 Nm <18 Nm) | GCA12x, GCA13x, GCA15x* | >62 lb-in <160 lb-in (>7 Nm <18 Nm) | GCA |
| >160 lb-in <320 lb-in (>18 Nm <36 Nm) | Use tandem mounting bracket ASK73.1 with any combination of: • GCA12x actuators • GCA13x actuators Use tandem mounting bracket ASK73.2U with any combination of GCA151 and GCA156 actuators.* | >160 lb-in <320 lb-in (>18 Nm <36 Nm) | Use tandem mounting bracket ASK73.1 with any combination of: • GCA12x actuators • GCA22x actuators • GCA13x actuators • Use tandem mounting bracket ASK73.2U with any combination of: • GCA151 and GCA156 actuators* • GCA161 and GCA166 actuators |

Mounting and Installation

Flip the actuator to select either clockwise or counterclockwise fail-safe rotation of the damper shaft. Follow steps 1, 2, and 3 of Table 3 to determine the correct actuator mounting orientation.

Table 3. Actuator Mounting Orientation and Damper Control.

| | | | | | | | |
|----------|---|--|---|---|---|---|---|
| EA105BR1 | Determining the Actuator Mounting Orientation | ① Damper Type |  | |  | | |
| | | ② Power Fail Spring Return Position |  Close |  Open |  Close |  Open | |
| | | ③ Actuator Mounting Orientation |  |  |  |  | |
| EA105FR1 | 2-Position | GMA12x |  Open |  Close |  Open |  Close | |
| | | GMA22x |  Open |  Close |  Open |  Close | |
| EA105FR1 | 3-Position | GMA13x | Y1  |  Open |  Close |  Open |  Close |
| | | | Y2  |  Open |  Close |  Open |  Close |
| | | GMA13x | Y1  |  Close |  Open |  Close |  Open |
| | | | Y2  |  Close |  Open |  Close |  Open |
| EA105BR1 | Modulating Control | GMA15x | Y = 10V Ω |  Open |  Close |  Open |  Close |
| | | | Y = 2V Ω | | | | |
| | | GMA16x | Y = 10V (or Y = U _o + ΔU) |  Close |  Open |  Close |  Open |
| | | | Y = 0V (or Y = U _o) | | | | |

- The shaft adapter and the position indicator can be mounted on either side of the actuator. The actuator mounting orientation and shaft length determine how they will be mounted on the actuator.
- The minimum damper drive shaft length is 3/4-inch (20 mm).
- See *Specifications* for the minimum and maximum damper shaft dimensions.
- The actuator is shipped from the factory with a 5° preload enabling tight close off of the damper in power-fail-close applications.
- A mounting bracket is included with the actuator.
- The shaft adapter and mounting parts are shipped in a separate container with the actuator.
- See the detailed mounting instructions included with each actuator.

Manual Override

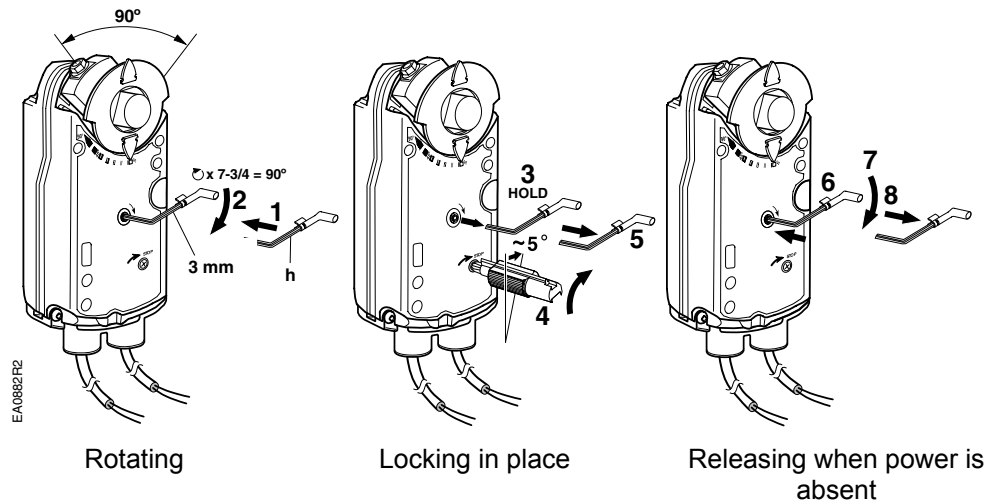

Figure 9. Manual Override.

NOTE: Always turn the key in the direction of the arrow.



CAUTION:

When engaging the gear train lock pin, carefully turn only about 5 degrees until you meet slight resistance. Turning too far will strip the lock pin.

To Release Manual Override

Do one of the following:

- Restore power and send a control signal.
- When power is absent, do the following:
 1. Insert the 3 mm hex key in the override opening.
 2. Turn the key in the direction of the arrow.
 3. Remove the key.

Mechanical Range Adjustment

The angular rotation is adjustable between 0° and 90° at 5-degree intervals.

To limit the range of shaft movement:

1. Remove the locking clip and self-adjusting shaft adapter.
2. Rotate the damper blade shaft to its failed position.
3. Rotate the shaft coupling to the desired position.
4. Insert the shaft adapter into the actuator and fasten it with the locking clip. See Figure 10.

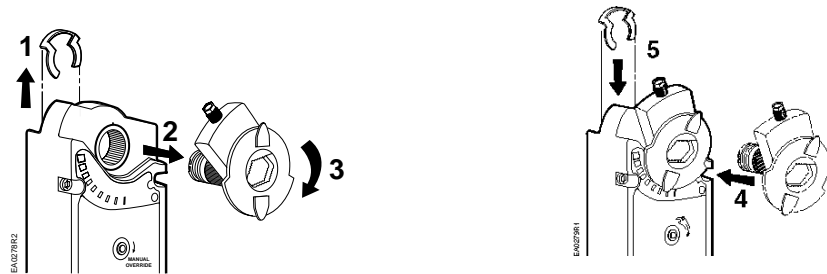

Figure 10. Mechanical Range Adjustment.

Control Signal Adjustment

(Offset and Span)

GMA163
GMA164

The offset (start point) and span of the control signal can be adjusted. The offset, U_o , can be adjusted between 0 to 5 Vdc. The span, ΔU , can be adjusted between 2 to 30 Vdc.

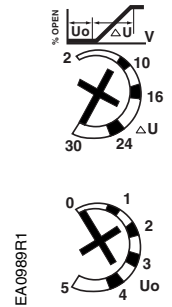
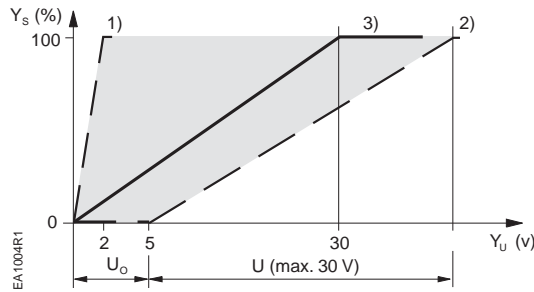

- Y_s Mechanical positioning range (100% = angle of rotation 90°)
- Y_u Control signal
- U_o Offset (start point)
- ΔU Span

Factory Setting
 of 30V span
 0 offset

1. $U_o = 0V, \Delta U = 2V$ The minimum working range for $Y_s = 100\%$
2. $U_o = 5V, \Delta U = 30V$ The maximum working range for $Y_s = 100\%$
3. $U_o = 0V, \Delta U \approx 30V$ Factory setting

Figure 11. The Minimum and Maximum Control Signal Adjustment.

Example:

Open the actuator from 0 to 50% (45°) using a control signal of:

$U_{min} = 2V$ to $U_{max} = 10V$

Calculating the value of ΔU :

$$\Delta U = \frac{100 [\%] (U_{max} - U_{min})}{\text{Working angle of rotation in } \%} = \frac{100 \times (10 - 2)}{50} = 16V$$

Settings

$U_o = 2V; \Delta U = 16V$

U_{min} = minimum control signal
 U_{max} = maximum control signal

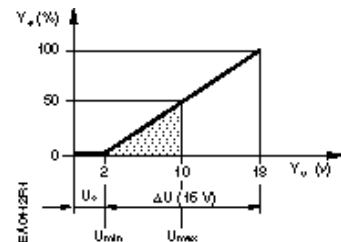
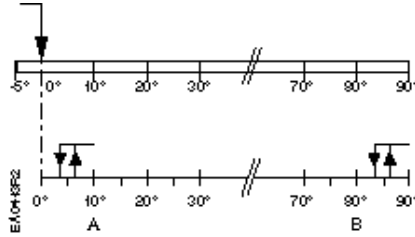

Figure 12. Example.

Dual Auxiliary Switch

GMA126
 GMA226
 GMA136
 GMA156
 GMA164
 GMA166



Actuator rotary range with the shaft adapter mounted at position "0".

Setting range for switches A and B
 Setting interval: 5°
 Switching hysteresis: 2°

To change the settings of A and B:

Make sure the actuator is in the "0", fail-safe position. The scale is valid only in the "0" position.

Use the adjustment tool provided with the actuator to turn the switch adjustment dials to the desired setting at which a signal is to be given.

Factory setting:

Switch A = 5°

Switch B = 85°

NOTE: Use the long arm of the "+" to point to the position of switch A. Use the narrower tab on the red ring to point to the position of switch B.

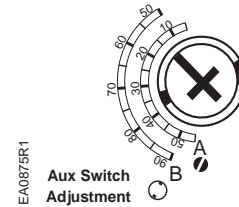

Figure 13. Adjustable Switching Values for the Dual Auxiliary Switches.

DIP Switch Functionality

GMA 151
 GMA 156

| Description | Label | Description | Function |
|-------------------------|-------|------------------------|---------------------------|
| Inverse Acting | | Direct-Acting | Input Signal Inversion |
| Inverse-Acting Feedback | | Direct-Acting feedback | Feedback Signal inversion |
| | | | Not In Use |

Figure 14. DIP Switches.

Input Signal Inversion



Allows inverting the control input signal

The arrow direction indicates opening or closing (closing or opening) when operating an actuator with a given control signal.

= Direct acting (Factory setting)
 Input signal 2 Vdc ► fail-safe position

= Inverse acting
 Input signal 10 Vdc ► fail-safe position

Feedback Signal Inversion



Allows inverting the position feedback output signal

= Direct acting feedback (Factory setting)
 Fail-safe position ► Output signal 2 Vdc

= Inverse acting feedback,
 Fail-safe position ► Output signal 10 Vdc

Wiring

All wiring must conform to NEC and local codes and regulations.

Use earth ground isolating step-down Class 2 transformers. Do not use autotransformers.

The maximum rating for a Class 2 step-down transformer is 100 VA. Determine the supply transformer rating by summing the VA ratings of all actuators and all other components used. It is recommended that one transformer power no more than 10 actuators (or 80% of its VA).



WARNING:

Mixed switch operation is not permitted to the switching outputs of both auxiliary switches (A and B).

Either AC line voltage from the same phase must be applied to all six outputs of the dual auxiliary switches, or UL-Class 2 voltage (SELV for CE conformance) must be applied to all six outputs.

NOTE: With Plenum cables only UL-Class 2 voltage (SELV for CE conformance) is permitted.



WARNING:

Installations requiring $\text{C}\epsilon$ Conformance:

- Except for the auxiliary switches (See *Warning* above) all wiring for 24 Vac/dc actuators must only be safety extra-low voltage (SELV) or protective extra-low voltage (PELV) per HD384.
- Use safety transformers per EN61558 with double isolation, designed for 100% duty-cycle for supplying SELV or PELV circuits.
- Over-current protection for supply lines is maximum 10A.

Wire Designations

Each wire has the standard symbol printed on it. See Table 4.

Table 4. Wire Designations.

| Applicable Actuator | Standard Symbol | Function | Terminal Designations | Color |
|---------------------|-----------------|---|-----------------------|------------|
| 24 Vac/dc | 1 | Supply (SP) | G | Red |
| | 2 | Neutral (SN) | G0 | Black |
| | 6 | Control signal clockwise | Y1 | Violet |
| | 7 | Control signal counterclockwise | Y2 | Orange |
| | 8 | Input signal: 0 to 10 Vdc (GMA16x) or 2 to 10 Vdc (GMA15x) | Y | Gray |
| 120 Vac | 9 | Position output: 0 to 10 Vdc (GMA16x) or 2 to 10 Vdc (GMA15x) | U | Pink |
| | 3 | Line | L | Black |
| Auxiliary Switches | 4 | Neutral | N | White |
| | S1 | Switch A – Common | Q11 | Gray/red |
| | S2 | Switch A – N.C. | Q12 | Gray/blue |
| | S3 | Switch A – N.O. | Q14 | Gray/pink |
| | S4 | Switch B – Common | Q21 | Black/red |
| | S5 | Switch B – N.C. | Q22 | Black/blue |
| Position Feedback | S6 | Switch B – N.O. | Q24 | Black/pink |
| | P1 | Feedback Potentiometer 0 to 100% P1 - P2 | a | White/red |
| | P2 | Feedback Potentiometer Common | b | White/blue |
| | P3 | Feedback Potentiometer 100 to 0% P3 – P2 | c | White/pink |

Wiring Diagrams

GMA12x
 24 Vac/dc
 2-Position Control

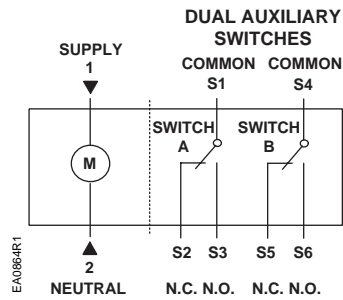

III
 Class 2

Figure 15.

GMA22x
 120 Vac
 2-Position Control

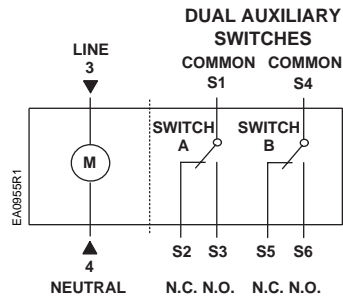
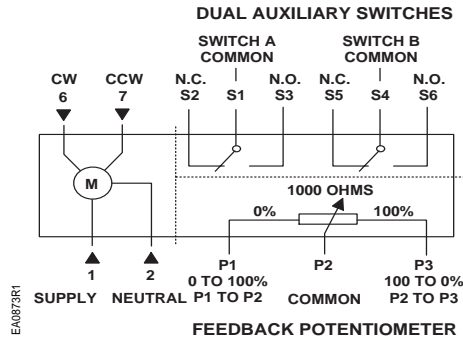

Figure 16.

GMA13x
 24 Vac/dc
 Floating Control



III
 Class 2

Figure 17.

GMA15x
GMA16x
 24 Vac/dc
 Modulating control

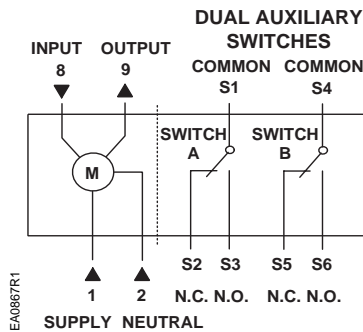

III
 Class 2

Figure 18.

Special Applications

4 to 20 mA
GMA15x

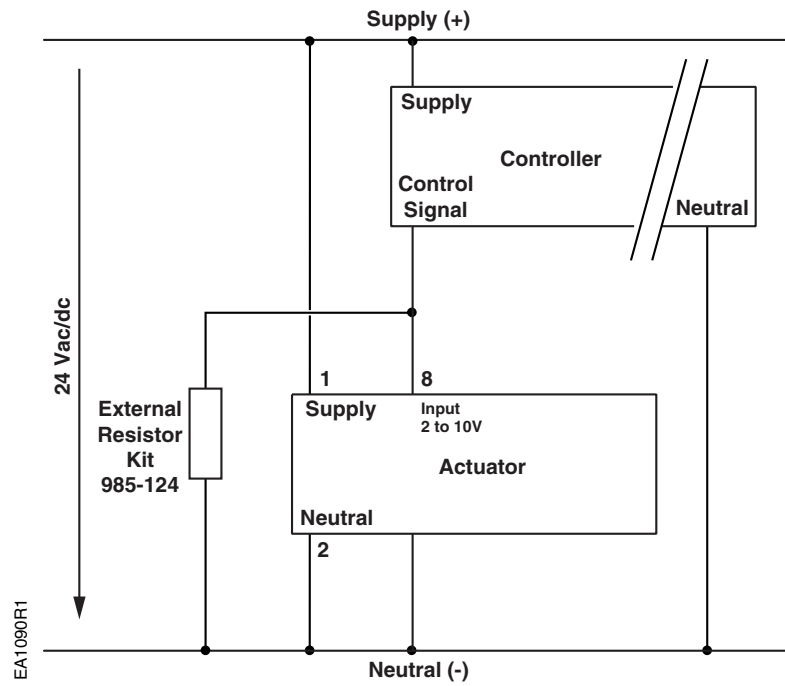

Figure 19. GMA 151 and GMA156, 4 to 20 mA Applications.

Start-Up/ Commissioning

GMA16x, GMA15x

Spring Return Modulating Control 24 Vac/dc

1. Check Operation:
 - a. Connect wires 1 (red) and 2 (black) to the 24 Vac/dc power supply.
NOTE: With no input signal present, the GMA15x actuator with input signal inversion switch set to Inverse Acting will start driving towards 90°.
 - b. Use a Digital Multimeter (DDM) and set the dial to Vdc for the actuator input signal.
 - c. Connect wires 2 (black) and 8 (gray) to the DMM.
 - d. Apply to input signal wire 8 (gray):
 $Y = 10 \text{ Vdc}$ or $Y = U_o + \Delta U$ (GMA16x)
 $Y = 10 \text{ Vdc}$ (GMA15x with input signal inversion switch set to Direct Acting)
 $Y = 2 \text{ Vdc}$ (GMA15x with input signal inversion switch set to Inverse Acting)
Allow the actuator shaft coupling to rotate from 0° to 90°.
 - e. Apply to input signal wire 8 (gray):
 $Y = 0 \text{ Vdc}$ or $Y = U_o$ (GMA16x)
 $Y = 2 \text{ Vdc}$ (GMA15x with input signal inversion switch set to Direct Acting)
 $Y = 10 \text{ Vdc}$ (GMA15x with input signal inversion switch set to Inverse Acting)
The shaft coupling returns to the "0" position.
-

2. Check Spring Return:
 - a. Set the DMM dial to Vdc.
 - b. Connect wires 2 (black) and 8 (gray) to the DMM.
 - c. Apply to input signal wire 8 (gray):
 $Y = 5 \text{ Vdc}$ or $Y = U_o + 1/2 \Delta U$ (GMA16x)
 $Y = 6 \text{ Vdc}$ (GMA15x)
Allow the actuator shaft coupling to rotate halfway.
 - d. Disconnect wire 1 (red).
The spring returns the actuator shaft coupling to the fail "0" position.
 - e. Connect wire 1 (red) and the actuator moves.
-

3. Check Feedback:
 - a. Set the DMM dial to Vdc.
 - b. Attach wires 2 (black) and 9 (pink) to the DMM.
 - c. Apply the input signal as in *Step 1d*, to wire 8 (gray).
The reading at the DMM should increase (decrease for GMA15x with output signal inversion switch set to Inverse Acting Feedback).
 - d. Apply the input signal as in *Step 1f*, to wire 8 (gray).
The reading at the DMM should decrease (increase for GMA 15x with output signal inversion switch set to Inverse Acting Feedback) and the actuator shaft coupling returns to the fail "0" position.
-

4. Check the Auxiliary Switch A:
 - a. Set the DMM dial to ohms (resistance) or continuity check.
 - b. Connect wires S1 and S3 to the DMM. The DMM should indicate open circuit or no resistance.
 - c. Apply the input signal as in *Step 1d*, to wire 8 (gray).
The DMM should indicate contact closure as the actuator shaft coupling reaches the setting of switch A.
 - d. Connect wires S1 and S2 to the DMM. The DMM should indicate open circuit or no resistance.
 - e. Apply the input signal as in *Step 1f*, to wire 8 (gray).
The DMM should indicate contact closure as the actuator shaft coupling reaches the setting of switch A.
-

**Start-Up/
Commissioning,
continued**

-
5. Check the Auxiliary Switch B:
 - a. Set the DMM dial to ohms (resistance) or continuity check.
 - b. Connect wires S4 and S6 to the DMM. The DMM should indicate open circuit or no resistance.
 - c. Apply the input signal as in *Step 1d*, to wire 8 (gray).
The DMM should indicate contact closure as the actuator shaft coupling reaches the setting of switch B.
 - d. Connect wires S4 and S5 to the DMM. The DMM should indicate open circuit or no resistance.
 - e. Apply the input signal as in *Step 1f*, to wire 8 (gray).
The DMM should indicate contact closure as the actuator shaft coupling reaches the setting of switch B.
-

GMA12x**Spring Return
2-Position
24 Vac/dc**

1. Check Operation:
 - a. Connect wires 1 (red) and 2 (black) to 24 Vac/dc power supply.
Allow the actuator shaft coupling to rotate from 0° to 90°.
 - b. Disconnect wire 1 (red) and the actuator shaft coupling returns to the "0" position.
 2. Check Spring Return:
 - a. Connect wire 1 (red).
Allow the actuator shaft coupling to rotate halfway.
 - b. Disconnect wire 1 (red).
The spring returns the actuator shaft coupling to the fail "0" position.
 3. Check the Auxiliary Switch A:
 - a. Set the DMM dial to ohms (resistance) or continuity check.
 - b. Connect wires S1 and S3 to the DMM.
The DMM should indicate open circuit or no resistance.
 - c. Connect wire 1 (red).
The DMM should indicate contact closure as the actuator shaft coupling reaches the setting of switch A.
 - d. Connect wires S1 and S2 to the DMM.
The DMM should indicate open circuit or no resistance.
 - e. Disconnect wire 1 (red).
The DMM should indicate contact closure as the actuator shaft coupling reaches the setting of switch A.
 4. Check the Auxiliary Switch B:
 - a. Set the DMM dial to ohms (resistance) or continuity check.
 - b. Connect wires S4 and S6 to the DMM.
The DMM should indicate open circuit or no resistance.
 - c. Connect wire 1 (red).
The DMM should indicate contact closure as the actuator shaft coupling reaches the setting of switch B.
 - d. Connect wires S4 and S5 to the DMM.
The DMM should indicate open circuit or no resistance.
 - e. Disconnect wire 1 (red).
The DMM should indicate contact closure as the actuator shaft coupling reaches the setting of switch B.
-

**Start-Up/
Commissioning,
continued**

GMA22x

**Spring Return
2-Position
120 Vac**



WARNING: Switch off 120 Vac power before connecting wires 3 (black) and 4 (white).

1. Check Operation:
 - a. Switch on 120 Vac power.
Allow the actuator shaft coupling to rotate from 0 to 90°.
 - b. Switch off 120 Vac power
The actuator shaft coupling will return to the fail "0" position.

2. Check Spring Return:
 - a. Switch on 120 Vac power.
Allow the actuator shaft coupling to rotate halfway.
 - b. Switch off 120 Vac power.
The spring returns the actuator shaft coupling to the fail "0" position.

3. Check the Auxiliary Switch A:
 - a. Set the DMM dial to ohms (resistance) or continuity check.
 - b. Connect wires S1 and S3 to the DMM.
The DMM should indicate an open circuit or no resistance.
 - c. Switch on 120 Vac power.
The DMM should indicate contact closure as the actuator shaft coupling reaches the setting of switch A.
 - d. Connect wires S1 and S2 to the DMM.
The DMM should indicate open circuit or no resistance.
 - e. Switch off 120 Vac power.
The DMM should indicate contact closure as the actuator shaft coupling reaches the setting of switch A.

4. Check the Auxiliary Switch B:
 - a. Set the DMM dial to ohms (resistance) or continuity check.
 - b. Connect wires S4 and S6 to the DMM.
The DMM should indicate open circuit or no resistance.
 - c. Switch on 120 Vac power.
The DMM should indicate contact closure as the actuator shaft coupling reaches the setting of switch B.
 - d. Connect wires S4 and S5 to the DMM.
The DMM should indicate open circuit or no resistance.
 - e. Switch off 120 Vac power.
The DMM should indicate contact closure as the actuator shaft coupling reaches the setting of switch B.

**Start-Up/
Commissioning,
continued****GMA13x
Spring Return
Floating
24 Vac/dc**

-
1. Check Operation:
 - a. Connect wires 1 (red) and 2 (black) to a 24 Vac/dc power supply.
 - b. Apply a control signal (24 Vac/dc) to wire 6 (violet).
Allow the actuator shaft coupling to rotate from 0 to 90°.
 - c. Stop the control signal to wire 6 (violet).
 - d. Apply a control signal (24 Vac/dc) to wire 7 (orange).
Allow the actuator shaft coupling to rotate from 90° to 0°.

 2. Check Spring Return:
 - a. Apply a control signal (24 Vac/dc) to wire 6 (violet).
Allow the actuator shaft coupling to rotate half way.
 - b. Disconnect wire 1 (red).
The spring returns the actuator shaft coupling to the fail "0" position.
 - c. Connect wire 1 (red).
The actuator shaft coupling begins to move.

 3. Check Feedback:
 - a. Set the DMM dial to ohms.
 - b. Connect wires P1 and P2 to the DMM.
The DMM should indicate a resistive value.
 - c. Apply a control signal (24 Vac/dc) to wire 6 (violet).
The reading of the DMM should increase.
 - d. Stop the control signal to wire 6 (violet).
 - e. Connect wires P2 and P3 to the DMM.
The DMM should indicate a resistive value.
 - f. Apply a control signal (24 Vac/dc) to wire 7 (orange).
The reading of the DMM should increase.

 4. Check the Auxiliary Switch A:
 - a. Set the DMM dial to ohms (resistance) or continuity check.
 - b. Connect wires S1 and S3 to the DMM.
The DMM should indicate an open circuit or no resistance.
 - c. Apply a control signal (24 Vac/dc) to wire 6 (violet).
The DMM should indicate contact closure as the actuator shaft coupling reaches the setting of switch A.
 - d. Stop the control signal to wire 6 (violet).
 - e. Connect wires S1 and S2 to the DMM.
The DMM should indicate an open circuit or no resistance.
 - f. Apply a control signal (24 Vac/dc) to wire 7 (orange).
The DMM should indicate contact closure as the actuator shaft coupling reaches the setting of switch A.
-

**Start-Up/
 Commissioning,
 continued**

GMA13x, continued

5. Check the Auxiliary Switch B:
 - a. Set the DMM dial to ohms (resistance) or continuity check.
 - b. Connect wires S4 and S6 to the DMM.
 The DMM should indicate an open circuit or no resistance.
 - c. Apply a control signal (24 Vac/dc) to wire 6 (violet).
 The DMM should indicate contact closure as the actuator shaft coupling reaches the setting of switch B.
 - d. Stop the control signal to wire 6 (violet).
 - e. Connect wires S4 and S5 to the DMM.
 The DMM should indicate an open circuit or no resistance.
 - f. Apply a control signal (24 Vac/dc) to wire 7 (orange).
 The DMM should indicate contact closure as the actuator shaft coupling reaches the setting of switch B.

Service



WARNING:

Do not open the actuator.
 If the actuator is inoperative, replace the unit.

Troubleshooting



WARNING:

To avoid injury or loss of life, pay attention to any hazardous voltage (For example, 120 Vac) when performing checks.

Check that the wires are connected correctly.

Check that span/offset (start point) and Dip switches are set correctly, if used.

Use a Digital Multimeter (DMM) to verify that the operating voltage is within range.

If the actuator is not working, check the damper for blockage. If blocked, remove the obstacle and cycle the actuator power off and on. The actuator should resume normal operating mode.

Dimensions

Inches (mm)

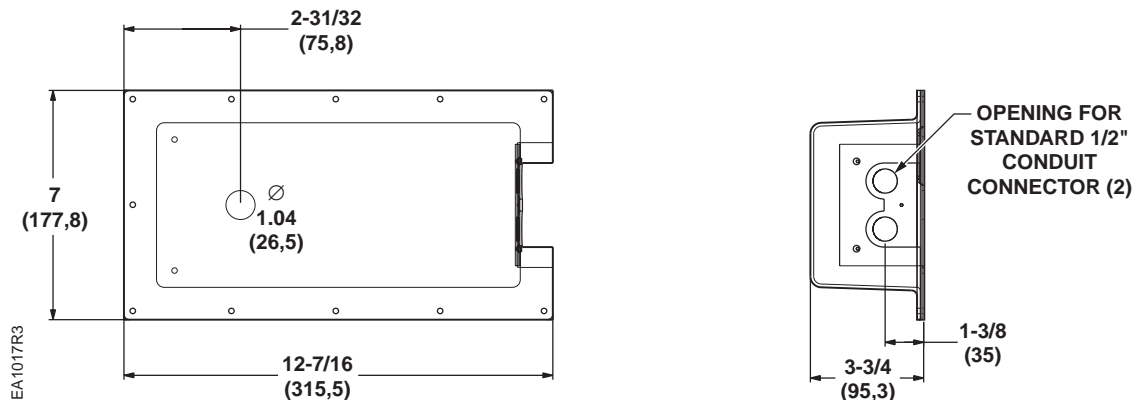

Figure 20. ASK75.3U Weather Shield Dimensions.

Dimensions, continued

Inches (mm)

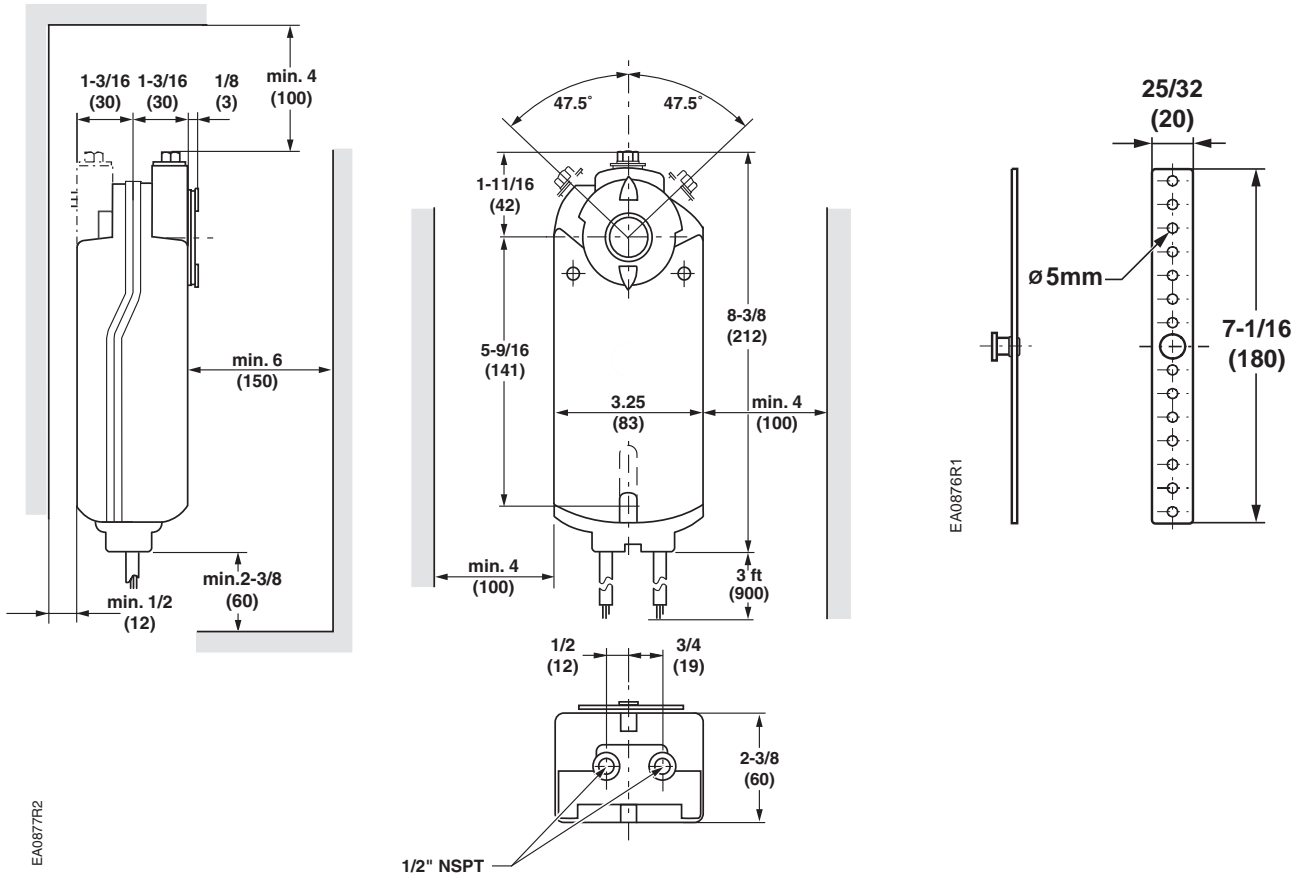

Figure 21. GMA Actuator and Mounting Bracket Dimensions.

Information in this publication is based on current specifications. The company reserves the right to make changes in specifications and models as design improvements are introduced. OpenAir is a registered trademark of Siemens Schweiz AG. Product or company names mentioned herein may be the trademarks of their respective owners. © 2011 Siemens Industry, Inc.